

# \*TB 9-6695-272-35

DEPARTMENT OF THE ARMY TECHNICAL BULLETIN

## CALIBRATION PROCEDURE FOR SYNTHESIZER/LEVEL GENERATOR, HEWLETT-PACKARD, MODEL 3335A AND 3335A OPT 001

Headquarters Department of the Army, Washington, DC  
17 May 2006

*Distribution Statement A: Approved for public release; distribution is unlimited.*

### REPORTING OF ERRORS AND RECOMMENDING IMPROVEMENTS

You can improve this manual. If you find any mistakes or if you know of a way to improve these procedures, please let us know. Mail your letter or DA Form 2028 (Recommended Changes to Publications and Blank Forms) directly to: Commander, US Army Aviation and Missile Command, AMSAM-MMC-MA-NP, Redstone Arsenal, AL 35898-5000. A reply will be furnished to you. You may also provide DA Form 2028 information to AMCOM via e-mail, fax, or the World Wide Web. Our fax number is DSN 788-6546 or Commercial 256-842-6546. Our e-mail address is [2028@redstone.army.mil](mailto:2028@redstone.army.mil). Instructions for sending an electronic 2028 may be found at the back of this manual. For the World Wide Web, use <https://amcom2028.redstone.army.mil>.

SECTION		Paragraph	Page
	I. IDENTIFICATION AND DESCRIPTION		
	Test instrument identification.....	1	2
	Forms, records, and reports .....	2	2
	Calibration description.....	3	2
	II. EQUIPMENT REQUIREMENTS		
	Equipment required .....	4	3
	Accessories required .....	5	3
	III. CALIBRATION PROCESS		
	Preliminary instructions .....	6	4
	Equipment setup .....	7	4
	Oscillator and stability.....	8	4
	Frequency .....	9	5
	Harmonic distortion .....	10	5
	Maximum output level .....	11	6
	Flatness .....	12	9
	Attenuator accuracy .....	13	11
	Power supply .....	14	12
	Final procedure.....	15	13

\*This bulletin supersedes TB 9-6695-272-35, 21 April 2004, including all changes.

## SECTION I IDENTIFICATION AND DESCRIPTION

**1. Test Instrument Identification.** This bulletin provides instructions for the calibration of Synthesizer/Level Generator, Hewlett-Packard, Model 3335A and 3335A OPT 001. The manufacturer's manual was used as the prime data source in compiling these instructions. The equipment being calibrated will be referred to as the TI (test instrument) throughout this bulletin.

**a. Model Variations.** Variations among models are described in text, tables, and figures.

**b. Time and Technique.** The time required for this calibration is approximately 3 hours, using the dc and low frequency and microwave technique.

### 2. Forms, Records, and Reports

**a.** Forms, records, and reports required for calibration personnel at all levels are prescribed by TB 750-25.

**b.** Adjustments to be reported are designated (R) at the end of the sentence in which they appear. When adjustments are in tables the (R) follows the designated adjustment. Report only those adjustments made and designated with (R).

**3. Calibration Description.** TI parameters and performance specifications which pertain to this calibration are listed in table 1.

Table 1. Calibration Description

Test instrument parameter	Performance specifications															
Frequency	Range: 200 Hz to 80 MHz Stability: $\pm 1 \times 10^{-8}$ per day (option 001, $< 5 \times 10^{-10}$ per day)															
Harmonic distortion	Frequency range: 100 kHz to 10 MHz Accuracy: $< -45$ dB Frequency range: 10 to 80 MHz Accuracy: $< -40$ dB															
Amplitude	Range: 50 $\Omega$ : +13.01 to -86.98 dBm Accuracy: $\pm 0.05$ dB															
Flatness	Range: 1 kHz to 25 MHz Accuracy: $\pm 0.07$ dB Range: 200 Hz to 80 MHz Accuracy: $\pm 0.15$ dB															
Attenuator	Range: 0 to 98 dB Accuracy: <sup>1</sup> <table style="margin-left: 20px; border: none;"> <tr> <td style="padding-right: 10px;">0</td> <td style="padding-right: 10px;">to</td> <td style="padding-right: 10px;">38</td> <td style="padding-right: 10px;"><math>\pm 0.025</math></td> <td style="padding-right: 10px;">dB</td> </tr> <tr> <td style="padding-right: 10px;">40</td> <td style="padding-right: 10px;">to</td> <td style="padding-right: 10px;">58</td> <td style="padding-right: 10px;"><math>\pm 0.03</math></td> <td style="padding-right: 10px;">dB</td> </tr> <tr> <td style="padding-right: 10px;">60</td> <td style="padding-right: 10px;">to</td> <td style="padding-right: 10px;">98</td> <td style="padding-right: 10px;"><math>\pm 0.09</math></td> <td style="padding-right: 10px;">dB</td> </tr> </table>	0	to	38	$\pm 0.025$	dB	40	to	58	$\pm 0.03$	dB	60	to	98	$\pm 0.09$	dB
0	to	38	$\pm 0.025$	dB												
40	to	58	$\pm 0.03$	dB												
60	to	98	$\pm 0.09$	dB												

<sup>1</sup>Calibrated to the accuracy of model 8902A.

## SECTION II EQUIPMENT REQUIREMENTS

**4. Equipment Required.** Table 2 identifies the specific equipment to be used in this calibration procedure. This equipment is issued with Secondary Transfer Calibration Standards Set AN/GSM-287 or AN/GSM-705. Alternate items may be used by the calibrating activity. The items selected must be verified to perform satisfactorily prior to use and must bear evidence of current calibration. The equipment must meet or exceed the minimum use specifications listed in table 2. The accuracies listed in table 2 provide a four-to-one ratio between the standard and TI. Where the four-to-one ratio cannot be met, the actual accuracy of the equipment selected is shown in parenthesis.

**5. Accessories Required.** The accessories required for this calibration are common usage accessories, issued as indicated in paragraph 4 above, and are not listed in this calibration procedure. The following peculiar accessories are also required for this calibration: Cable, 8-in., SMA plug terminations (WEI-15851001); Extender boards, supplied with TI.

Table 2. Minimum Specifications of Equipment Required

Common name	Minimum use specifications	Manufacturer and model (part number)
CALIBRATOR	Range: 1 Vac @ 100 kHz Accuracy: $\pm 0.144\%$ (Used to characterize multimeter to meet AC accuracy @ 100 kHz)	Fluke, Model 5720A (5700A/EP) (p/o MIS-35947)
FREQUENCY COUNTER	Range: 199 Hz to 80 MHz Accuracy: $1 \times 10^{-9}$	Fluke, Model PM6681/656 (PM6681/656)
FREQUENCY DIFFERENCE METER	Resolution: 1 part in $10^{-10}$	Tracor, Model 527E
MEASURING RECEIVER	Range: Frequency 40 MHz Attenuator 10 dB to -90 dB Accuracy: $\pm 0.02$ dB/10 dB	Hewlett-Packard, Model 8902A w/sensor, Hewlett-Packard, Model 11722A (11722A)
MULTIMETER	Range: 0 to 15.01 V dc Accuracy: $\pm 0.06\%$ 0.005 to 1.0 V ac Accuracy: 0.125% @ 10 kHz Accuracy: 100 kHz (See calibrator)	Hewlett-Packard, Model 3458A (3458A)
POWER METER	Range: 10 to 25 MHz Accuracy: $\pm 0.312\%$ ( $\pm 1.25\%$ ) Range: 26 to 80 MHz Accuracy: $\pm 0.875\%$ ( $\pm 1.25\%$ )	Hewlett-Packard, Model 437B (13440045) w/thermistor mount 8482A (13440043)
SPECTRUM ANALYZER	Range: 100 kHz To 80 MHz Dynamic range: -45 dB	(AN/USM-489A)
THERMAL CONVERTER	Range: 200 Hz to 10 MHz Accuracy: See test report	Ballantine, Model 1395A-1 (7913198-2)
TIME/FREQUENCY WORKSTATION	Frequency: 1 MHz Accuracy: 1 part in $10^{-10}$	Datum, Model ET6000-75 (13589305)

### SECTION III CALIBRATION PROCESS

#### 6. Preliminary Instructions

a. The instructions outlined in paragraphs 6 and 7 are preparatory to the calibration process. Personnel should become familiar with the entire procedure before beginning the calibration.

b. Items of equipment used in this procedure are referenced within the text by common name as listed in table 2.

c. Unless otherwise specified, verify the result of each test and, whenever the test requirement is not met, take corrective action before continuing with the calibration. Adjustments required to calibrate the TI are included in this procedure. Additional maintenance information is contained in the manufacturer's manual for this TI.

d. When indications specified in paragraphs 8 through 13 are not within tolerance, perform the power supply check prior to making adjustments. After adjustments are made, repeat paragraphs 8 through 13. Do not perform power supply check if all other parameters are within tolerance.

e. Unless otherwise specified, all controls and control settings refer to the TI.

#### 7. Equipment Setup

##### WARNING

HIGH VOLTAGE is used or exposed during the performance of this calibration. DEATH ON CONTACT may result if personnel fail to observe safety precautions. REDUCE OUTPUT(S) to minimum after each step within the performance check where applicable.

a. Connect TI to a 115 V ac source.

b. Press **ON-STBY/POWER** pushbutton to **ON**, and allow at least 24 hours for TI to reach operating temperature.

c. Set **50 Ω/75 Ω** switch to **50 Ω**.

d. Connect **10 MHz REF OVEN OUTPUT** to **40/N M/Hz REF INPUT** (rear panel), using BNC to BNC adapter supplied with TI.

#### 8. Oscillator and Stability

##### a. Performance Check

(1) Connect **1 MHz OUTPUT** of time/frequency workstation to **REF INPUT** of frequency difference meter.

(2) Connect TI **10 MHz OUTPUT** (rear panel) to **SIG INPUT** of frequency difference meter.

**NOTE**

Remove bottom cover to gain access to **FREQ ADJ**. Remove **FREQ ADJ** screw to provide access to adjustment (option 001).

(3) Adjust **FREQ ADJ** for minimum difference indication on frequency difference meter.

(4) Allow at least 24 hours for oscillator to stabilize. Frequency difference meter indication will stay within  $1 \times 10^{-8}$  ( $< 5 \times 10^{-10}$  per day for option 001).

**b. Adjustments.** No further adjustments can be made.

**9. Frequency**

**a. Performance Check**

(1) Connect TI **10 MHz OUTPUT** (rear panel) to frequency counter **REFERENCE IN** (rear panel).

(2) Press **EXT REF** on frequency counter to utilize external reference.

(3) Connect **OUTPUT 200 Hz-80 MHz 50 Ω** to frequency counter **A** input.

(4) Press **FREQUENCY, 200, Hz/deg, AMPLITUDE, 13.01, and kHz/+dBm** pushbuttons. Frequency counter will indicate between 199 and 201 Hz.

(5) Press **FREQUENCY** and **DATA** pushbuttons as listed in table 3. Frequency counter will indicate within limits specified.

Table 3. Frequency Accuracy Check

Test instrument FREQUENCY and DATA settings (MHz)	Frequency counter indications (MHz)	
	Min	Max
5	4.999 999	5.000 001
10.999 999	10.999 998	11.000 000
14.5	14.499 999	14.500 001
20	19.999 999	20.000 001
28.123 456	28.123 455	28.123 457
40	39.999 999	40.000 001
60	59.999 999	60.000 001
80	79.999 999	80.000 001

**b. Adjustments.** No adjustments can be made.

**10. Harmonic Distortion**

**a. Performance Check**

(1) Connect TI **OUTPUT 200 Hz-80 MHz 50 Ω** to spectrum analyzer.

(2) Press **FREQUENCY, 100, kHz/+dBm, AMPLITUDE, 13.01, and kHz/+dBm** pushbuttons.

**TB 9-6695-272-35**

(3) Adjust spectrum analyzer controls to display fundamental frequency (100 kHz) and at least four harmonics. All harmonics will be at least 45 dB below fundamental.

(4) Repeat technique of (2) and (3) above for frequencies listed in table 4. Spectrum analyzer will indicate within limits specified.

**b. Adjustments.** No adjustments can be made.

Table 4. Harmonic Distortion

Test instrument frequencies (MHz)	Spectrum analyzer indications (dB)
1	<-45
5	<-45
10	<-45
20	<-40
40	<-40
80	<-40

**11. Maximum Output Level**

**a. Performance Check**

(1) Execute multimeter ACAL AC command by pressing keys as listed in (a) through (c) below:

- (a) **MENU Auto Cal.**
- (b) **FUNCTION/RANGE Menu Scroll** ↓ until **ACAL AC** is displayed.
- (c) **NUMERIC/USER 3458** then **Enter**.

**NOTE**

ACAL AC takes approximately 1 minute to complete.

- (2) Connect calibrator **OUTPUT** to multimeter **INPUT HI** and **LO** terminals.
- (3) Set calibrator for a 1.00574 V, 100 kHz output.
- (4) Record multimeter reading as indication #1.
- (5) Set calibrator for a 0.99423 V, 100 kHz output.
- (6) Record multimeter reading as indication #2.
- (7) Press calibrator **STBY** and disconnect from multimeter.
- (8) Connect **TI OUTPUT 200 Hz-80 MHz 50 Ω**, through 50 Ω feed-through termination, to multimeter **INPUT HI** and **LO** terminals.
- (9) Press **FREQUENCY, 100, kHz/+dBm, AMPLITUDE, 13.01,** and **kHz/+dBm** pushbuttons.
- (10) Note multimeter reading. If reading does not indicate between the recorded indication #1 and indication #2 readings, perform **b** below.

## b. Adjustments

- (1) Press **ON-STBY/POWER** pushbutton to **OFF**.
- (2) Remove top cover.
- (3) Remove three bolts that hold module to chassis (fig. 1).
- (4) Remove semi rigid coaxial cable (fig. 1).

### CAUTION

When performing (5) below, ensure that all cables remain in place.

- (5) Turn TI on side and remove module from chassis (fig. 1).
- (6) Remove assemblies A6 and A7 (fig. 1) and place on extender boards.
- (7) Install cable from A6 **OUTPUT LEVELING** to output attenuator (fig. 1).
- (8) Press **ON-STBY/POWER** pushbutton to **ON**, then press **10, kHz/+dBm, AMPLITUDE, 13.01, kHz/+dBm** pushbuttons.
- (9) Ground A6TP5 (fig. 2).
- (10) Connect multimeter between A6TP6 (fig. 2) and chassis ground. Adjust **BIAS ADJ A6R85** (fig. 2) for  $0\text{ V} \pm 0.01\text{ V}$  dc (R).
- (11) Remove ground from A6TP5 and adjust **DC NULL ADJ A7R92** (fig. 3) for  $0\text{ V} \pm 0.01\text{ V}$  dc (R).
- (12) Press **ON-STBY/POWER** pushbutton to **OFF**.

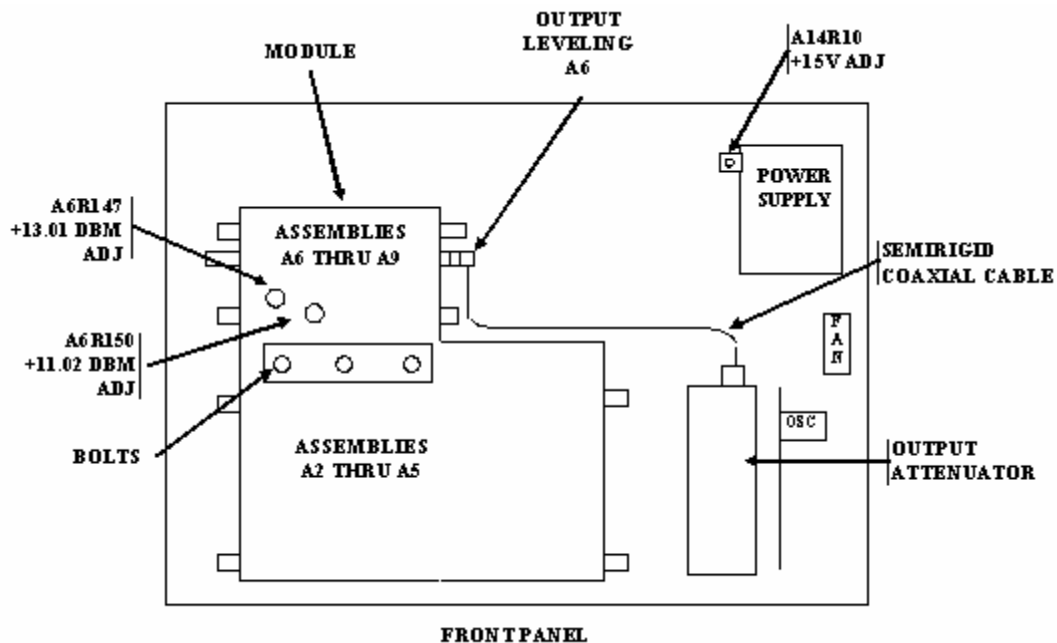

Figure 1. Test Instrument – top view.

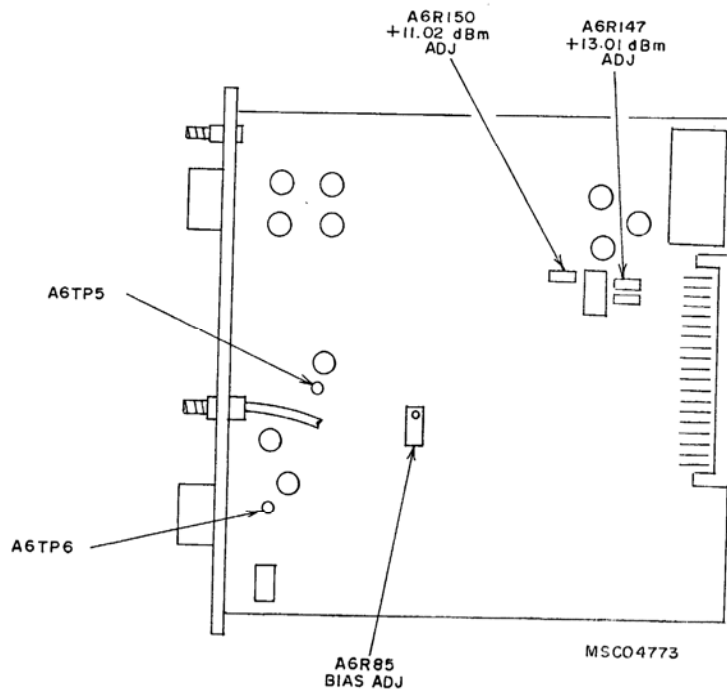

Figure 2. A6 output amp/level control.

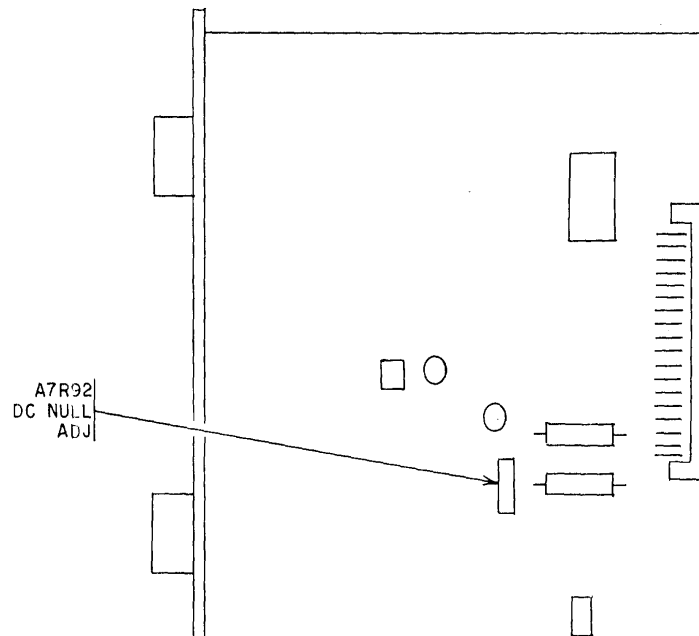

Figure 3. A7 mixer.



- (13) Remove extender boards and reinstall assemblies A6 and A7 (fig. 1) into module.
- (14) Replace module in chassis and secure.
- (15) Replace semi rigid coaxial cable removed in (4) above.
- (16) Repeat **a** (8) above.
- (17) Press **ON-STBY/POWER** pushbutton to **ON** and allow TI to operate at least 30 minutes.
- (18) Press **10, kHz/+dBm, AMPLITUDE, 13.01, and kHz/+dBm** pushbuttons.
- (19) Adjust A6R147 (fig. 2) (+13.01 dBm ADJ) for 1 V  $\pm$ 0.005 V ac on multimeter. Note and record the difference from 1 V (R).
- (20) Press **AMPLITUDE, 11.02, and kHz/+dBm** pushbuttons.
- (21) Adjust A6R150 (fig. 2) (+11.02 dBm ADJ) for a multimeter reading listed in table 5 corresponding to the difference recorded in (19) above (R).

Table 5. +11.02 dBm ADJ Specifications

A6R147 +13.01 dBm <b>ADJ</b> difference (V)	A6R150, +11.02 dBm <b>ADJ</b> adjustment specifications
+0.005	+0.799 $\pm$ .001
+0.004	+0.798 $\pm$ .001
+0.003	+0.797 $\pm$ .001
+0.002	+0.797 $\pm$ .001
+0.001	+0.796 $\pm$ .001
$\pm$ 0.000	+0.795 $\pm$ .001
-0.001	+0.794 $\pm$ .001
-0.002	+0.793 $\pm$ .001
-0.003	+0.793 $\pm$ .001
-0.004	+0.792 $\pm$ .001
-0.005	+0.791 $\pm$ .001

**12. Flatness**

**a. Performance Check**

- (1) Connect equipment as shown in figure 4, CONNECTION A.

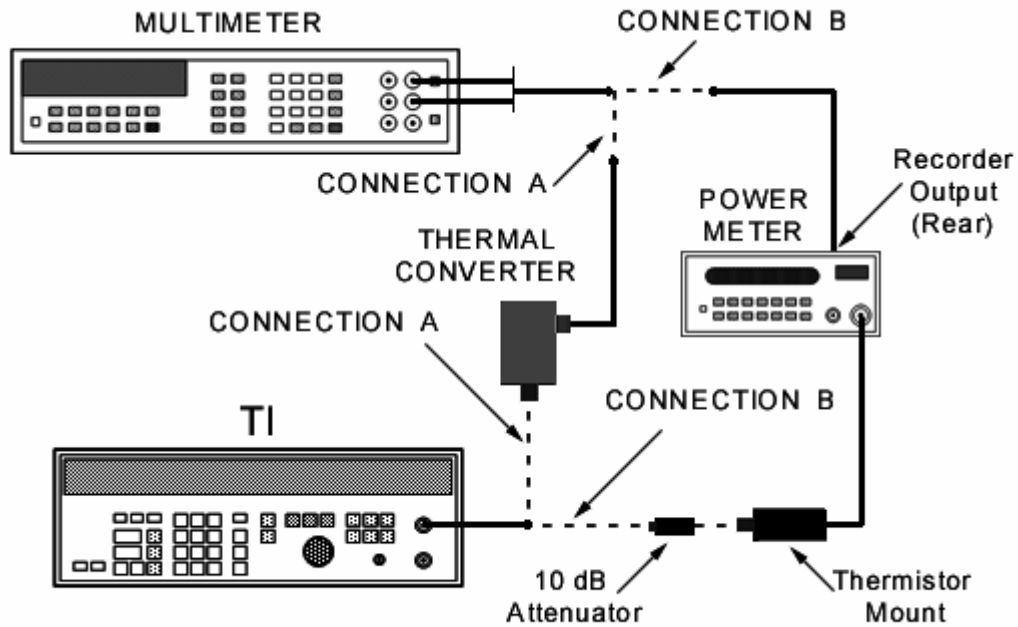

Figure 4. Flatness.

**NOTE**

It may be necessary to add thermal converter correctional data for frequency readings that are not within tolerance, or interrelate for frequency not checked on thermal converter calibration report. Allow thermal converter to settle before readings are recorded.

- (2) Set **FREQUENCY** to 100 kHz and press +13.01 dBm.
- (3) Record multimeter reading.
- (4) Press +12.91 dBm.
- (5) Record multimeter reading.
- (6) Calculate the allowable tolerance by subtracting reading in (5) above from reading in (3) above.
- (7) Record tolerance.
- (8) Reset amplitude to +13.01 dBm.
- (9) Set TI to the following frequencies, allow multimeter reading to settle and record the reading: 200 Hz, 50 kHz, 500 kHz, 1 MHz, 5 MHz, and 10 MHz (see **NOTE** above).
- (10) The result for each frequency must indicate the reading of (3) above  $\pm$  the tolerance established in (7) above.
- (11) Disconnect figure 4, CONNECTION A, equipment and reconnect as shown in figure 4, CONNECTION B.

- (12) Press TI **FREQUENCY** to 10 MHz and **AMPLITUDE** to +13.01 dBm.
- (13) Adjust power meter **CAL FACTOR** control set for power sensor.
- (14) Record multimeter reading.
- (15) Press +12.86 dBm.
- (16) Record multimeter reading.
- (17) Calculate the allowable tolerance by subtracting reading in (16) above from the reading in (14) above.
- (18) Record tolerance.
- (19) Reset amplitude to +13.01 dBm.
- (20) Set the TI to the following frequencies and record the multimeter readings: 20, 30, 40, 50, 60, 70, and 80 MHz.
- (21) The result for each frequency must indicate the reading of (14) above  $\pm$  the tolerance established in (18) above.

**b. Adjustments.** No adjustments can be made.

### 13. Attenuator Accuracy (50 $\Omega$ )

#### a. Performance Check

- (1) Connect equipment as shown in figure 5.

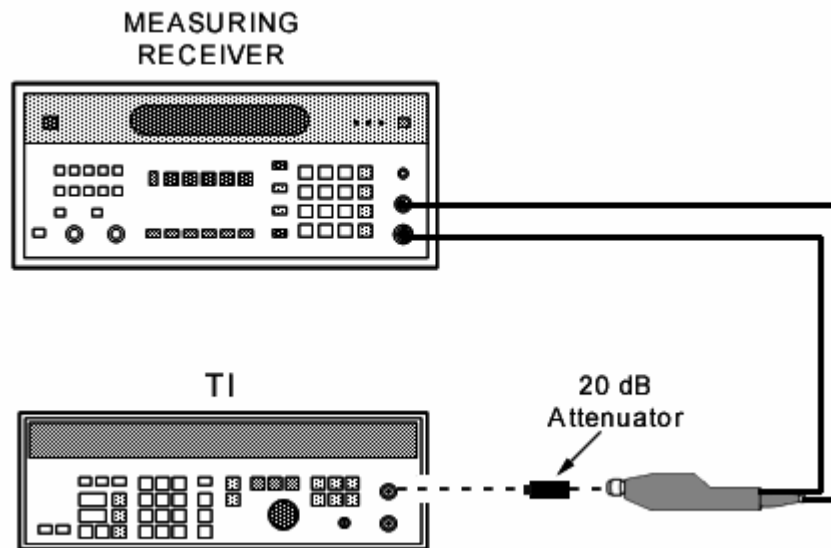

Figure 5. Attenuator accuracy.

- (2) Press TI **FREQUENCY** to 40 MHz and **AMPLITUDE** to +13.01 dBm.
- (3) Establish a reference on measuring receiver for Tuned RF Level at 40.0 MHz.

**TB 9-6695-272-35**

(4) Set TI to values listed in table 6 below. Using measuring receiver and Tuned RF Level measurement techniques, measured power will indicate within limits specified.

**NOTE**

The output attenuator consists of a group of fixed attenuators. These are used in a series combination to total 0 dB to -98 dB. Therefore, a total of 60 dB will constitute a complete calibration of all attenuators as all values above 60 dB are duplicated.

Table 6. Attenuator Accuracy (50 Ω)

Test instrument range	Min	Max
+13.01	REFERENCE	
+11.01	1.975	2.025
+9.01	3.975	4.025
+5.01	7.975	8.025
+3.01	9.975	10.025
-6.99	19.975	20.025
-26.99	39.97	40.03
-46.99	59.91	60.09

**14. Power Supply**

**NOTE**

Do not perform power supply check if all other parameters are within tolerance.

**a. Performance Check**

(1) Assemblies A2 through A9 (fig. 1) must be installed before adjustments can be made.

(2) Connect multimeter to +15 V and chassis ground located on A1 motherboard (fig. 6). If multimeter does not indicate between 14.99 and 15.01 V dc, perform **b** below.

**b. Adjustments.** Adjust A14R10 (+15 V ADJ) (fig. 1) for a 15 V dc indication on multimeter (R).

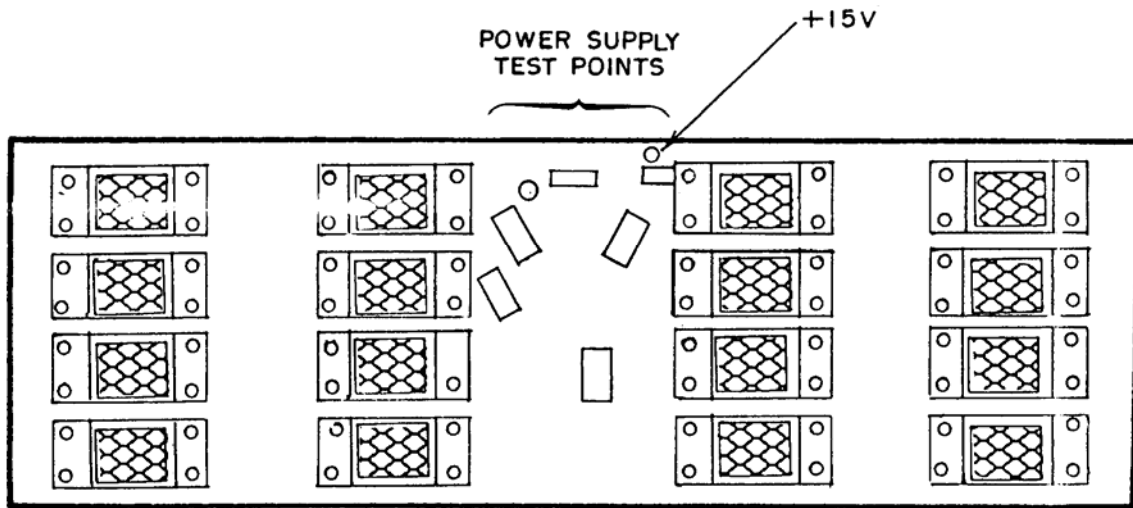

Figure 6. AI mother board.

### 15. Final Procedure

- a. Deenergize and disconnect all equipment.
- b. Annotate and affix DA label/form in accordance with TB 750-25.



By Order of the Secretary of the Army:

Official:

**PETER J. SCHOOMAKER**  
*General, United States Army*  
*Chief of Staff*

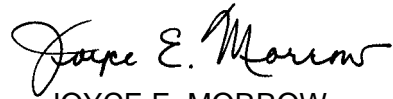

JOYCE E. MORROW  
*Administrative Assistant to the*  
*Secretary of the Army*

0608631

Distribution:

To be distributed in accordance with the initial distribution number (IDN) 342314, requirements for calibration procedure TB 9-6695-272-35.





### Instructions for Submitting an Electronic 2028

The following format must be used if submitting an electronic 2028. The subject line must be exactly the same and all fields must be included; however, only the following fields are mandatory: 1, 3, 4, 5, 6, 7, 8, 9, 10, 13, 15, 16, 17, and 27.

From: "Whomever" [whomever@redstone.army.mil](mailto:whomever@redstone.army.mil)  
To: <2028@redstone.army.mil

Subject: DA Form 2028

1. **From:** Joe Smith
2. **Unit:** home
3. **Address:** 4300 Park
4. **City:** Hometown
5. **St:** MO
6. **Zip:** 77777
7. **Date Sent:** 19-OCT-93
8. **Pub no:** 55-2840-229-23
9. **Pub Title:** TM
10. **Publication Date:** 04-JUL-85
11. **Change Number:** 7
12. **Submitter Rank:** MSG
13. **Submitter FName:** Joe
14. **Submitter MName:** T
15. **Submitter LName:** Smith
16. **Submitter Phone:** 123-123-1234
17. **Problem:** 1
18. **Page:** 2
19. **Paragraph:** 3
20. **Line:** 4
21. **NSN:** 5
22. **Reference:** 6
23. **Figure:** 7
24. **Table:** 8
25. **Item:** 9
26. **Total:** 123
27. **Text**

This is the text for the problem below line 27.





